



Cable Ties and Fixings

Q-Series

Innovative, easy to use and quick cable bundling and fixings

HellermannTyton

	Page
Introduction of Q-Series	3
Introduction of Q-tie cable ties	4
Q-ties, Polyamide 6.6 (PA66), natural and black	6
Q-ties, Polyamide 6.6 UV-resistant (PA66W), black	7
Q-ties, Polyamide 6.6 heat stabilised (PA66HS), natural and black	8
Q-ties, Polyamide 6.6 (PA66), coloured	9
Self Adhesive/Screw Fixing Cable Tie Mounts QM(A)	12
Screw Fixing Cable Tie Mounts CTQM	13
Q-tags, Identification Tags	14
Application tools for Q-ties	15

Q-series

Cable Ties, Q-tie

The Q-tie is a unique and innovative product for bundling and fixing cables for a wide range of applications. It is available in various colours and materials. The innovative design of the open head tie provides an easy insertion even under difficult circumstances.

A wide range of products is available:

- Polyamide 6.6 (PA66), black, natural and in various colours
- Polyamide 6.6 weather-resistant (PA66W), only black
- Polyamide 6.6 heat stabilised (PA66HS), black and natural

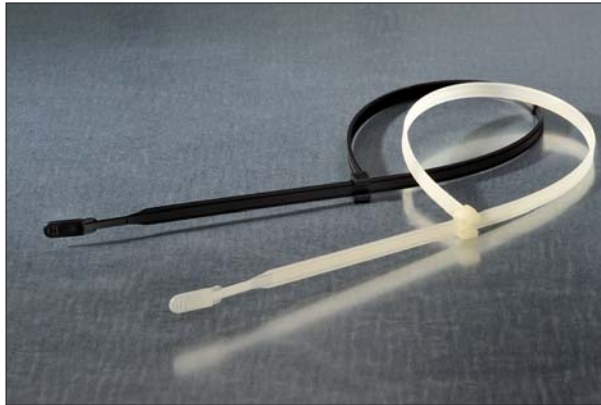

Cable tie, Q-tie.

Self adhesive/screw fixing Cable tie mounts QM(A)

The mounting bases Q-mounts are an ideal complement for Q-ties. Design and functionality of the mounting bases match perfectly to provide an optimised working process. Different types and sizes are available:

- 4-way mounts (QM)
- 2-way mounts (CTQM)
- Screwable/Self adhesive mounts
- Polyamide 6.6 (PA66), black, natural



Mounting Bases Q-mount.

Q-tags, Identification Tags

Besides fastening and fixing, the identification of cables is another important aspect of cable management. The Q-tag cable markers can be perfectly used with Q-ties. The tags offer different options for marking:

- manual with marker pen
- with adhesive label



The flagged orientation of Q-tags ensures that printed texts are easily visible.

Q-tie Cable Tie

Innovative – Effective – Safe!

The new Q-tie has not only an innovative but also a revolutionary design. The open head of the cable tie enables a simple and quick installation. Just insert the ergonomically bent tail into the open side of the head and tighten the cable tie.

With Q-ties you can save time and money!

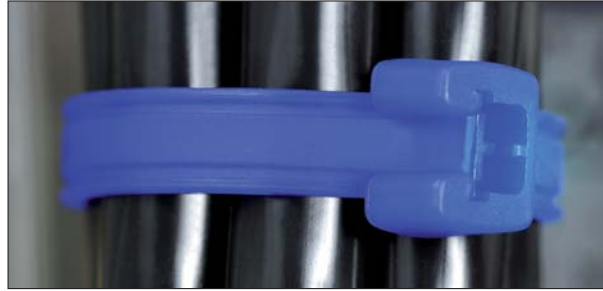

The head design makes the difference.

Easy application for every situation!

Q-tie is the perfect product solution for applications under difficult working conditions. It is designed for use in applications where working with gloves is necessary or for blind applications with a limited view of the work.

The new Q-tie allows a quick and simple installation even with work gloves and restricted view.

Features for quick and easy application:

- Curved and large ribbed tail
- Open head with easy detectable slot

This saves time and trouble!



Even under difficult circumstances the Q-ties are very fast and easy to apply.

Integrated Pre-Locking Functionality!

Due to several simultaneous working processes, it is not always possible to install all cables and conduits in one single step. Thus, working with standard cable ties means either destroying the cable tie of the first installation or applying additional cable ties. The integrated pre-locking function of the Q-tie offers the ability of a temporary and final cable fastening solution.

This saves material and time!

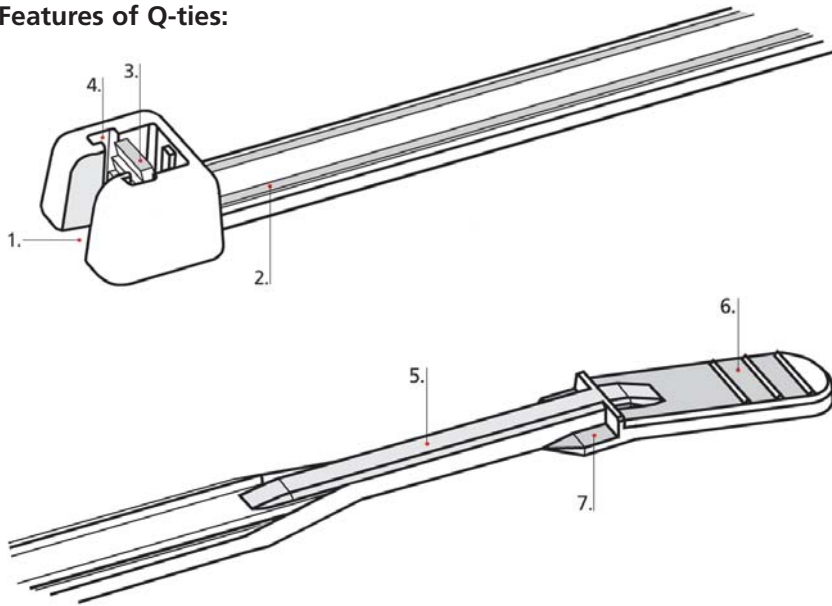

Without additional effort only Q-ties can be used for temporary and final cable bundling.

Features of Q-ties:

1. Open lock head for quick and easy insertion.
2. Two rails on the strap ensure a perfect guidance for the tracks in the head.
3. The locking device interacts safely with the serration of the cable tie.
4. The tracks prevent a deformation of the head under load.
5. The thin part of the cable tie can be simply placed into the open lock head.
6. The large ribbed tail allows a safe and ergonomic installation.
7. Integrated pre locking feature (starts with type Q30).

Application Method:

1. Insert the thin part of the cable tie into the open lock head.

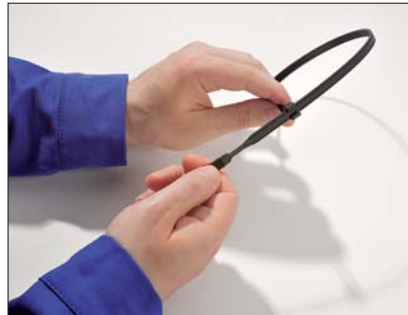

2. Pull the tie through the head until the bundle is fixed.
3. Cut off the remaining part of the tie with an application tool.

Pre-locking Function of the Q-tie:

1. Insert tail into lock head and push tail partly in the head.

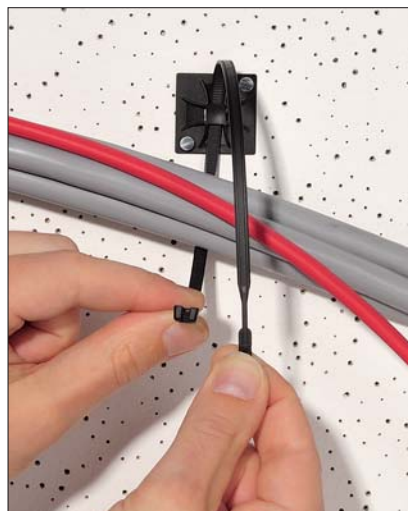

2. To release the tie push tail end slightly out of head.



3. If installation is finished, Q-tie can be tightened and cut off - either manually or with an application tool.

Q-ties, Polyamide 6.6 (PA66), natural and black

Application Tool	Registration Numbers
MK3SP	1
MK3PNSP2, MK7P	2
MK7	3
MK7HT	4
MK20	5
MK6	6
MK9P	7
MK9	8
MK9HT	9
MK21	10

For detailed information on Application Tools please refer to page 15.



Q-tie cable ties: choose from a wide product range in different materials.

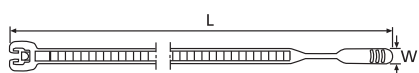

Q-tie cable tie

Material Data	
Material	Polyamide 6.6 (PA66)
Colour	Natural (NA), Black (BK)
Operating Temperature	-40 °C to +85 °C continuous, (+105 °C for 500 h)
Flammability	UL94 V2



Technical Table

Article-No.	Type	Length (L)	Width (W)	Bundle Ø max.	Min. Tensile Strength (N)	Material	Colour	Application Tool
Polyamide 6.6 (PA66)								
109-00001	Q18R	105	2.6	24.0	80	PA66	Natural (NA)	1-3, 5
109-00004	Q18I	155	2.6	40.0	80	PA66	Natural (NA)	1-3, 5
109-00007	Q18L	195	2.6	50.0	80	PA66	Natural (NA)	1-3, 5
109-00010	Q30R	160	3.6	38.0	130	PA66	Natural (NA)	1-3, 5
109-00012	Q30L	200	3.6	50.0	130	PA66	Natural (NA)	1-3, 5
109-00014	Q30LR	250	3.6	65.0	130	PA66	Natural (NA)	1-3, 5
109-00018	Q50R	210	4.7	50.0	220	PA66	Natural (NA)	1-10
109-00020	Q50I	290	4.7	75.0	220	PA66	Natural (NA)	1-10
109-00022	Q50L	410	4.7	110	220	PA66	Natural (NA)	1-10
109-00024	Q120I	300	7.7	70.0	530	PA66	Natural (NA)	6-10
109-00026	Q120R	420	7.7	110	530	PA66	Natural (NA)	6-10
109-00028	Q120M	520	7.7	145	530	PA66	Natural (NA)	6-10
109-00030	Q18R	105	2.6	24.0	80	PA66	Black (BK)	1-3, 5
109-00033	Q18I	155	2.6	40.0	80	PA66	Black (BK)	1-3, 5
109-00036	Q18L	195	2.6	50.0	80	PA66	Black (BK)	1-3, 5
109-00039	Q30R	160	3.6	38.0	130	PA66	Black (BK)	1-3, 5
109-00041	Q30L	200	3.6	50.0	130	PA66	Black (BK)	1-3, 5
109-00043	Q30LR	250	3.6	65.0	130	PA66	Black (BK)	1-3, 5
109-00047	Q50R	210	4.7	50.0	220	PA66	Black (BK)	1-10
109-00049	Q50I	290	4.7	75.0	220	PA66	Black (BK)	1-10
109-00051	Q50L	410	4.7	110	220	PA66	Black (BK)	1-10
109-00053	Q120I	300	7.7	70.0	530	PA66	Black (BK)	6-10
109-00055	Q120R	420	7.7	110	530	PA66	Black (BK)	6-10
109-00057	Q120M	520	7.7	145	530	PA66	Black (BK)	6-10

All dimensions in mm. Subject to technical changes.

Q-ties, Polyamide 6.6 UV-resistant (PA66W), black

Application Tool	Registration Numbers
MK3SP	1
MK3PNSP2, MK7P	2
MK7	3
MK7HT	4
MK20	5
MK6	6
MK9P	7
MK9	8
MK9HT	9
MK21	10

For detailed information on Application Tools please refer to page 15.



Q-tie cable ties: choose from a wide product range in different materials.

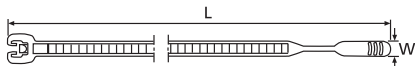

Q-tie cable tie

Material Data	
Material	Polyamide 6.6 UV-resistant (PA66W)
Colour	Black (BK)
Operating Temperature	-40 °C to +85 °C continuous, (+105 °C for 500 h)
Flammability	UL94 V2



Technical Table

Article-No.	Type	Length (L)	Width (W)	Bundle Ø max.	Min. Tensile Strength (N)	Material	Colour	Application Tool
Polyamide 6.6. UV Stabilised								
109-00059	Q18R	105	2.6	24.0	80	PA66W	Black (BK)	1-3, 5
109-00062	Q18I	155	2.6	40.0	80	PA66W	Black (BK)	1-3, 5
109-00065	Q18L	195	2.6	50.0	80	PA66W	Black (BK)	1-3, 5
109-00068	Q30R	160	3.6	38.0	130	PA66W	Black (BK)	1-3, 5
109-00070	Q30L	200	3.6	50.0	130	PA66W	Black (BK)	1-3, 5
109-00072	Q30LR	250	3.6	65.0	130	PA66W	Black (BK)	1-3, 5
109-00076	Q50R	210	4.7	50.0	220	PA66W	Black (BK)	1-10
109-00078	Q50I	290	4.7	75.0	220	PA66W	Black (BK)	1-10
109-00080	Q50L	410	4.7	110	220	PA66W	Black (BK)	1-10
109-00082	Q120I	300	7.7	70.0	530	PA66W	Black (BK)	6-10
109-00084	Q120R	420	7.7	110	530	PA66W	Black (BK)	6-10
109-00086	Q120M	520	7.7	145	530	PA66W	Black (BK)	6-10

All dimensions in mm. Subject to technical changes.

Q-ties, Polyamide 6.6 heat stabilised (PA66HS), natural and black

Application Tool	Registration Numbers
MK3SP	1
MK3PNSP2, MK7P	2
MK7	3
MK7HT	4
MK20	5
MK6	6
MK9P	7
MK9	8
MK9HT	9
MK21	10

For detailed information on Application Tools please refer to page 15.



Q-tie cable ties: choose from a wide product range in different materials.

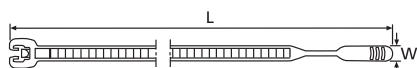

Q-tie cable tie

Material Data	
Material	Polyamide 6.6 heatstabilised (PA66HS)
Colour	Natural (NA), Black (BK)
Operating Temperature	-40 °C to +105 °C continuous, (+145 °C for 500 h)
Flammability	UL94 V2



Technical Table

Article-No.	Type	Length (L)	Width (W)	Bundle Ø max.	Min. Tensile Strength (N)	Material	Colour	Application Tool
Polyamide 6.6. Heat Stabilised								
109-00117	Q18R	105	2.6	24.0	80	PA66HS	Natural (NA)	1-3, 5
109-00120	Q18I	155	2.6	40.0	80	PA66HS	Natural (NA)	1-3, 5
109-00123	Q18L	195	2.6	50.0	80	PA66HS	Natural (NA)	1-3, 5
109-00126	Q30R	160	3.6	38.0	130	PA66HS	Natural (NA)	1-3, 5
109-00128	Q30L	200	3.6	50.0	130	PA66HS	Natural (NA)	1-3, 5
109-00130	Q30LR	250	3.6	65.0	130	PA66HS	Natural (NA)	1-3, 5
109-00134	Q50R	210	4.7	50.0	220	PA66HS	Natural (NA)	1-10
109-00136	Q50I	290	4.7	75.0	220	PA66HS	Natural (NA)	1-10
109-00138	Q50L	410	4.7	110.0	220	PA66HS	Natural (NA)	1-10
109-00140	Q120I	300	7.7	70.0	530	PA66HS	Natural (NA)	6-10
109-00142	Q120R	420	7.7	110.0	530	PA66HS	Natural (NA)	6-10
109-00144	Q120M	520	7.7	145.0	530	PA66HS	Natural (NA)	6-10
109-00088	Q18R	105	2.6	24.0	80	PA66HS	Black (BK)	1-3, 5
109-00091	Q18I	155	2.6	40.0	80	PA66HS	Black (BK)	1-3, 5
109-00094	Q18L	195	2.6	50.0	80	PA66HS	Black (BK)	1-3, 5
109-00097	Q30R	160	3.6	38.0	130	PA66HS	Black (BK)	1-3, 5
109-00099	Q30L	200	3.6	50.0	130	PA66HS	Black (BK)	1-3, 5
109-00101	Q30LR	250	3.6	65.0	130	PA66HS	Black (BK)	1-3, 5
109-00105	Q50R	210	4.7	50.0	220	PA66HS	Black (BK)	1-10
109-00107	Q50I	290	4.7	75.0	220	PA66HS	Black (BK)	1-10
109-00109	Q50L	410	4.7	110.0	220	PA66HS	Black (BK)	1-10
109-00111	Q120I	300	7.7	70.0	530	PA66HS	Black (BK)	6-10
109-00113	Q120R	420	7.7	110.0	530	PA66HS	Black (BK)	6-10
109-00115	Q120M	520	7.7	145.0	530	PA66HS	Black (BK)	6-10

All dimensions in mm. Subject to technical changes.

Q-ties, Polyamide 6.6 (PA66), coloured

Application Tool	Registration Numbers
MK3SP	1
MK3PNSP2, MK7P	2
MK7	3
MK7HT	4
MK20	5
MK6	6
MK9P	7
MK9	8
MK9HT	9
MK21	10

For detailed information on Application Tools please refer to page 15.

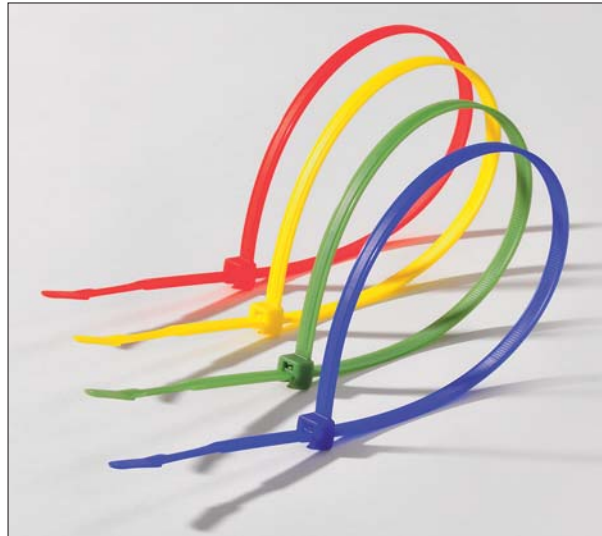

Q-ties in different colours are ideal for marking and bundling in one step.

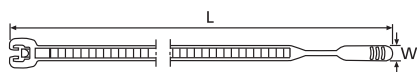

Q-tie cable tie

Material Data	
Material	Polyamide 6.6 (PA66)
Colour	Brown (BN), Blue (BU), Green (GN), Red (RD), Yellow (YE)
Operating Temperature	-40 °C to +85 °C continuous, (+105 °C for 500 h)
Flammability	UL94 V2



Technical Table

Article-No.	Type	Length (L)	Width (W)	Bundle Ø max.	Min. Tensile Strength (N)	Material	Colour	Application Tool
Polyamide 6.6 Coloured								
109-00146	Q18R	105	2.6	24.0	80	PA66	Brown (BN)	1-3, 5
109-00147	Q18R	105	2.6	24.0	80	PA66	Blue (BU)	1-3, 5
109-00148	Q18R	105	2.6	24.0	80	PA66	Green (GN)	1-3, 5
109-00149	Q18R	105	2.6	24.0	80	PA66	Red (RD)	1-3, 5
109-00150	Q18R	105	2.6	24.0	80	PA66	Yellow (YE)	1-3, 5
109-00151	Q18I	155	2.6	40.0	80	PA66	Brown (BN)	1-3, 5
109-00152	Q18I	155	2.6	40.0	80	PA66	Blue (BU)	1-3, 5
109-00153	Q18I	155	2.6	40.0	80	PA66	Green (GN)	1-3, 5
109-00154	Q18I	155	2.6	40.0	80	PA66	Red (RD)	1-3, 5
109-00155	Q18I	155	2.6	40.0	80	PA66	Yellow (YE)	1-3, 5
109-00156	Q18L	195	2.6	50.0	80	PA66	Brown (BN)	1-3, 5
109-00157	Q18L	195	2.6	50.0	80	PA66	Blue (BU)	1-3, 5
109-00158	Q18L	195	2.6	50.0	80	PA66	Green (GN)	1-3, 5
109-00159	Q18L	195	2.6	50.0	80	PA66	Red (RD)	1-3, 5
109-00160	Q18L	195	2.6	50.0	80	PA66	Yellow (YE)	1-3, 5
109-00161	Q30R	160	3.6	38.0	130	PA66	Brown (BN)	1-3, 5
109-00162	Q30R	160	3.6	38.0	130	PA66	Blue (BU)	1-3, 5
109-00163	Q30R	160	3.6	38.0	130	PA66	Green (GN)	1-3, 5
109-00164	Q30R	160	3.6	38.0	130	PA66	Red (RD)	1-3, 5
109-00165	Q30R	160	3.6	38.0	130	PA66	Yellow (YE)	1-3, 5
109-00166	Q30L	200	3.6	50.0	130	PA66	Brown (BN)	1-3, 5
109-00167	Q30L	200	3.6	50.0	130	PA66	Blue (BU)	1-3, 5
109-00168	Q30L	200	3.6	50.0	130	PA66	Green (GN)	1-3, 5
109-00169	Q30L	200	3.6	50.0	130	PA66	Red (RD)	1-3, 5
109-00170	Q30L	200	3.6	50.0	130	PA66	Yellow (YE)	1-3, 5

All dimensions in mm. Subject to technical changes.

Q-ties, Polyamide 6.6 (PA66), coloured

Application Tool	Registration Numbers
MK3SP	1
MK3PNSP2, MK7P	2
MK7	3
MK7HT	4
MK20	5
MK6	6
MK9P	7
MK9	8
MK9HT	9
MK21	10

For detailed information on Application Tools please refer to page 15.

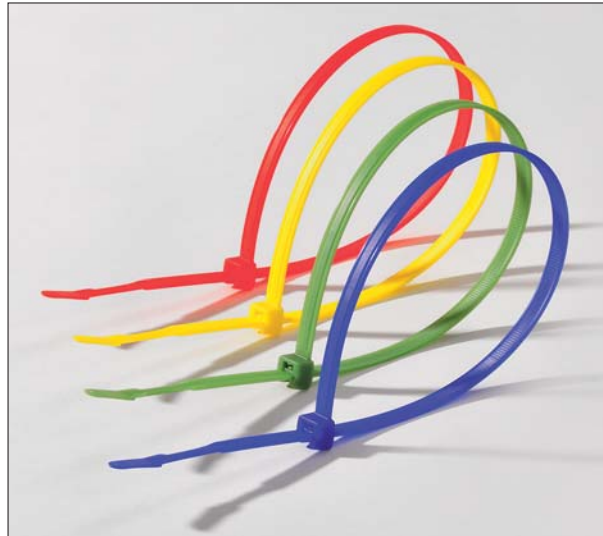

Q-ties in different colours are ideal for marking and bundling in one step.

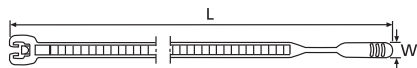

Q-tie cable tie

Material Data	
Material	Polyamide 6.6 (PA66)
Colour	Brown (BN), Blue (BU), Green (GN), Red (RD), Yellow (YE)
Operating Temperature	-40 °C to +85 °C continuous, (+105 °C for 500 h)
Flammability	UL94 V2



Technical Table

Article-No.	Type	Length (L)	Width (W)	Bundle Ø max.	Min. Tensile Strength (N)	Material	Colour	Application Tool
Polyamide 6.6 Coloured								
109-00171	Q30LR	250	3.6	65.0	130	PA66	Brown (BN)	1-3, 5
109-00172	Q30LR	250	3.6	65.0	130	PA66	Blue (BU)	1-3, 5
109-00173	Q30LR	250	3.6	65.0	130	PA66	Green (GN)	1-3, 5
109-00174	Q30LR	250	3.6	65.0	130	PA66	Red (RD)	1-3, 5
109-00175	Q30LR	250	3.6	65.0	130	PA66	Yellow (YE)	1-3, 5
109-00181	Q50R	210	4.7	50.0	220	PA66	Brown (BN)	1-10
109-00182	Q50R	210	4.7	50.0	220	PA66	Blue (BU)	1-10
109-00183	Q50R	210	4.7	50.0	220	PA66	Green (GN)	1-10
109-00184	Q50R	210	4.7	50.0	220	PA66	Red (RD)	1-10
109-00185	Q50R	210	4.7	50.0	220	PA66	Yellow (YE)	1-10
109-00186	Q50I	290	4.7	75.0	220	PA66	Brown (BN)	1-10
109-00187	Q50I	290	4.7	75.0	220	PA66	Blue (BU)	1-10
109-00188	Q50I	290	4.7	75.0	220	PA66	Green (GN)	1-10
109-00189	Q50I	290	4.7	75.0	220	PA66	Red (RD)	1-10
109-00190	Q50I	290	4.7	75.0	220	PA66	Yellow (YE)	1-10
109-00191	Q50L	410	4.7	110	220	PA66	Brown (BN)	1-10
109-00192	Q50L	410	4.7	110	220	PA66	Blue (BU)	1-10
109-00193	Q50L	410	4.7	110	220	PA66	Green (GN)	1-10
109-00194	Q50L	410	4.7	110	220	PA66	Red (RD)	1-10
109-00195	Q50L	410	4.7	110	220	PA66	Yellow (YE)	1-10

All dimensions in mm. Subject to technical changes.

Q-ties, Polyamide 6.6 (PA66), coloured

Application Tool	Registration Numbers
MK3SP	1
MK3PNSP2, MK7P	2
MK7	3
MK7HT	4
MK20	5
MK6	6
MK9P	7
MK9	8
MK9HT	9
MK21	10

For detailed information on Application Tools please refer to page 15.

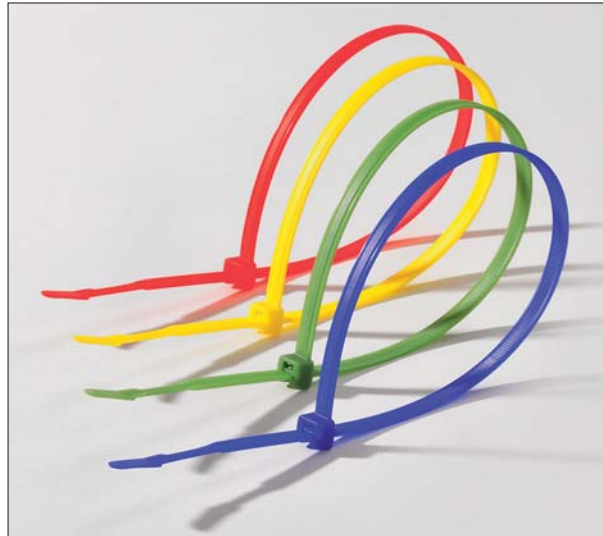

Q-ties in different colours are ideal for marking and bundling in one step.

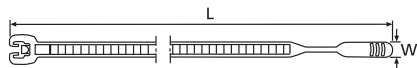

Q-tie cable tie

Material Data	
Material	Polyamide 6.6 (PA66)
Colour	Brown (BN), Blue (BU), Green (GN), Red (RD), Yellow (YE)
Operating Temperature	-40 °C to +85 °C continuous, (+105 °C for 500 h)
Flammability	UL94 V2



Technical Table

Article-No.	Type	Length (L)	Width (W)	Bundle Ø max.	Min. Tensile Strength (N)	Material	Colour	Application Tool
Polyamide 6.6 Coloured								
109-00196	Q120I	300	7.7	70.0	530	PA66	Brown (BN)	6-10
109-00197	Q120I	300	7.7	70.0	530	PA66	Blue (BU)	6-10
109-00198	Q120I	300	7.7	70.0	530	PA66	Green (GN)	6-10
109-00199	Q120I	300	7.7	70.0	530	PA66	Red (RD)	6-10
109-00200	Q120I	300	7.7	70.0	530	PA66	Yellow (YE)	6-10
109-00201	Q120R	420	7.7	110	530	PA66	Brown (BN)	6-10
109-00202	Q120R	420	7.7	110	530	PA66	Blue (BU)	6-10
109-00203	Q120R	420	7.7	110	530	PA66	Green (GN)	6-10
109-00204	Q120R	420	7.7	110	530	PA66	Red (RD)	6-10
109-00205	Q120R	420	7.7	110	530	PA66	Yellow (YE)	6-10
109-00206	Q120M	520	7.7	145	530	PA66	Brown (BN)	6-10
109-00207	Q120M	520	7.7	145	530	PA66	Blue (BU)	6-10
109-00208	Q120M	520	7.7	145	530	PA66	Green (GN)	6-10
109-00209	Q120M	520	7.7	145	530	PA66	Red (RD)	6-10
109-00210	Q120M	520	7.7	145	530	PA66	Yellow (YE)	6-10

All dimensions in mm. Subject to technical changes.

Self Adhesive/Screw Fixing Cable Tie Mounts QM(A)

Q-mounts allow a "4-way" entry for Q-ties and are available in a screwable or self adhesive version. Due of the special design of the mounting base, they offer a perfect solution in combination with the Q-tie cable ties. The Q-mount keeps the Q-tie in place during pre-assembly and ensures that the Q-tie does not slip out even in difficult situations, for example vertical mounting positions.



Q-mount QM, 4-way entry, adhesive/screwable.

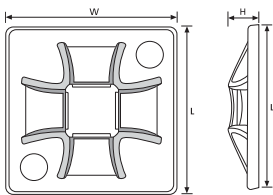

Mounting Base Q-mount

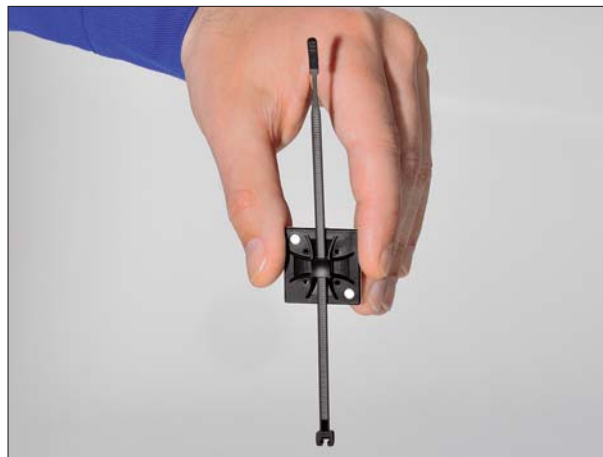

The Q-mount base locks the Q-tie in vertical position, your hands are free to apply the cables.

Synthetic rubber	
Base	PE foam
Temperature range	at least -40°C to +60°C

Material Data	
Material	Polyamide 6.6 (PA66)
Colour	Natural (NA), Black (BK)
Operating Temperature	-40 °C to +85 °C continuous, (+105 °C for 500 h)
Flammability	UL94 V2 (excluding adhesive)

Technical Table

Article-No.	Type	Length (L)	Width (W)	Height (H)	Fixing Hole Ø (FH)	Strap Width max. (G)	Material	Colour	Adhesive
151-10901	QM20	20.0	20.0	3.7	3.1	4.0	PA66	Natural (NA)	–
151-10902	QM30	30.0	30.0	4.5	4.1	5.1	PA66	Natural (NA)	–
151-10903	QM40	40.0	40.0	5.5	4.1	8.4	PA66	Natural (NA)	–
151-10904	QM20A	20.0	20.0	3.7	3.1	4.0	PA66	Natural (NA)	Synthetic rubber
151-10905	QM30A	30.0	30.0	4.5	4.1	5.1	PA66	Natural (NA)	Synthetic rubber
151-10906	QM40A	40.0	40.0	5.5	4.1	8.4	PA66	Natural (NA)	Synthetic rubber
151-10911	QM20	20.0	20.0	3.7	3.1	4.0	PA66	Black (BK)	–
151-10912	QM30	30.0	30.0	4.5	4.1	5.1	PA66	Black (BK)	–
151-10913	QM40	40.0	40.0	5.5	4.1	8.4	PA66	Black (BK)	–
151-10914	QM20A	20.0	20.0	3.7	3.1	4.0	PA66	Black (BK)	Synthetic rubber
151-10915	QM30A	30.0	30.0	4.5	4.1	5.1	PA66	Black (BK)	Synthetic rubber
151-10916	QM40A	40.0	40.0	5.5	4.1	8.4	PA66	Black (BK)	Synthetic rubber

All dimensions in mm. Subject to technical changes.

Screw Fixing Cable Tie Mounts CTQM

The "2-way" mounting bases CTQM provide a safe guiding of cables and conduits.

- For cable ties up to 5 mm width
- The base is mounted with a screw with countersunk head (max. \varnothing of head: 8,0mm)

The Q-mount offers a perfect solution in combination with the Q-tie cable ties. It keeps the inserted cable tie in place during pre-assembly and ensures that the Q-tie does not slip out even in difficult situations, for example vertical mounting positions.



Q-mount, CTQM 2-way entry, screwable.

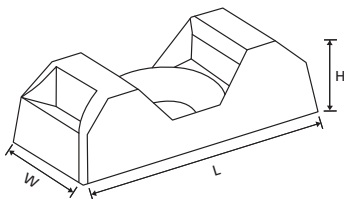

Mounting base CTQM

Material Data	
Material	Polyamide 6.6 (PA66)
Colour	Natural (NA), Black (BK)
Operating Temperature	-40 °C to +85 °C continuous, (+105 °C for 500 h)
Flammability	UL94 V2



Technical Table

Article-No.	Type	Length (L)	Width (W)	Height (H)	Fixing Hole \varnothing (FH)	Strap Width max. (G)	Material	Colour
151-10920	CTQM5	21.0	9.5	6.7	4.5	5.0	PA66	Natural (NA)
151-10930	CTQM5	21.0	9.5	6.7	4.5	5.0	PA66	Black (BK)

All dimensions in mm. Subject to technical changes.

Q-tags, Identification Tags

Features and Benefits

Q-tags are used to identify a cable or a cable bundle and are secured with a Q-tie. The Q-tag's flag design allows the user to quickly read or scan the printed information. The tags can be marked by hand with a marker pen (T82 series) or with a printed adhesive label. HellermannTyton offers a complete printing solution for Q-tags: printers, labels, ribbons, and market leading label design software; Tagprint Pro V2. Using Q-ties and Q-tags gives users the confidence that cables and cable bundles are safely secured and the text is highly visible.



The flagged orientation of Q-tags ensures that printed texts are easily visible.

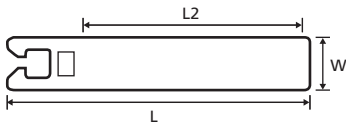

Q-tag QT7016R

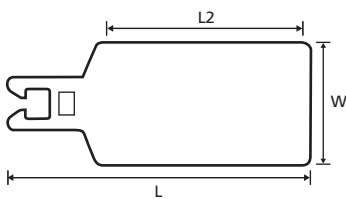

Q-tag QT7040R

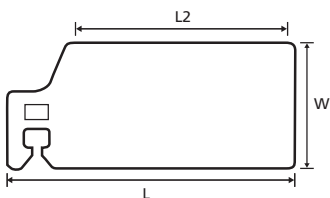

Q-tag QT7040S



Q-tags are available in different sizes and types.



Q-tags can be labelled with pre-printed labels or by hand.

Material Data	
Material	Polyamide 6.6 (PA66)
Colour	White (WH)
Operating Temperature	-40 °C to +85 °C continuous, (+105 °C for 500 h)
Flammability	UL94 V2



Technical Table

Article-No.	Type	Length (L)	Length (L2)	Width (W)	Strap Width max. (G)	Pack Cont.	Colour
151-10950	QT7016R	100.0	70.0	18.0	4.7	50	White (WH)
151-10951	QT7040R	100.0	70.0	42.0	4.7	50	White (WH)
151-10952	QT7040S*	100.0	70.0	42.0	3.6	50	White (WH)
151-10953	QT10065R	135.0	100.0	67.0	4.7	25	White (WH)
Marker pens T82							
500-50820	T82S-BK	-	-	-	-	2	Black (BK)
500-50822	T82R-RD	-	-	-	-	2	Red (RD)

All dimensions in mm. Subject to technical changes.

* right angled

Manual Processing Tools for Q-Ties



MK20, MK21



MK3SP



MK7



MK7HT



MK6



MK9



MK9HT

For detailed information on
Application Tools please refer to
our main catalogue chapter 6.2.

Pneumatic Tensioning Tools for Q-Ties



MK3PNSP2



MK7P



MK9P

For further information please contact:

HellermannTyton

HellermannTyton GmbH
Obachgasse 6
1221 Wien
Tel: +43 (0) 1 259 99 55-0
Fax: +43 (0) 1 259 99 11
E-Mail: office@HellermannTyton.at
www.HellermannTyton.at